

230 & 231 DYNAMICAL®

thermostatic radiator valves
inc low flow



230 & 231 DYNAMICAL® thermostatic radiator valves



Function

The DYNAMICAL® thermostatic radiator valves allows the automatic dynamic balancing and pressure-independent adjustment of the thermal medium in the radiators of two-pipe heating systems.

The device, in conjunction with a thermostatic, electronic or thermo-electric controller, combines different functions into a single component.

The use of dynamic thermostatic valves in combination with thermostatic control heads makes it possible to keep the ambient temperature constant, at the set value, in the room where they are installed, thus guaranteeing effective energy saving.

Product Range

- 230402LF 1/2" low flow dynamic thermostatic valve - angled
- 230402 1/2" dynamic thermostatic radiator valve - angled
- 231402LF 1/2" low flow dynamic thermostatic valve - straight
- 231402 1/2" dynamic thermostatic radiator valve - straight
- 105-1520LF 15mm low flow TRV with thermostatic controller - angled
- 105-1520 15mm TRV with thermostatic controller - angled
- 105-1521 LF 15mm low flow TRV with thermostatic controller - straight
- 105-1521 15mm TRV with thermostatic controller - straight

Materials

Component	Material	Grade
Body	Brass - chrome plated	BS EN 12165 CW617N
Obturator control stem	Stainless Steel	
Hydraulic seals	Elastomer	EPDM
Control knob	ABS polymer (PANTONE 356C)	

Performance

Medium:		Water, glycol solution
Max percentage of glycol:		30%
Max differential pressure with control fitted		1.5 bar
Maximum working pressure:		10 bar
Nominal Δp control range:	low flow	(reg. 1-6) 10–150 kPa (reg. 1-4) 10–150 kPa (reg. 5-6) 15–150 kPa
Flow rate regulation range:	low flow	0.16 - 1.33 l/min 0.33–2 l/min
Thermal medium working temperature range:		5 – 95°C
Factory pre-setting:		position 6

Dimensions - including low flow

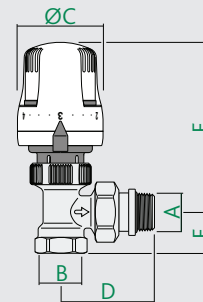

Code	A	B	C	D	E	F
230402 + 200001	G1/2B	G1/2	48	52.5	23	103

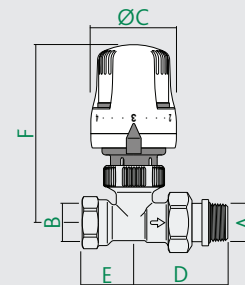

Code	A	B	C	D	E	F
231402 + 200001	G1/2B	G1/2	48	52.5	29	106

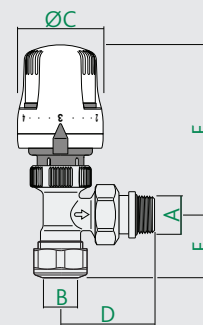

Code	A	ØB	C	D	E	F
105-1520	G1/2B	15	48	52.5	30	103

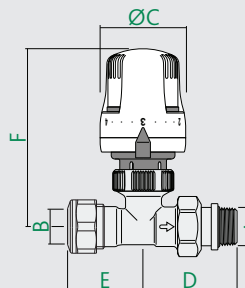

Code	A	ØB	C	D	E	F
105-1521	G1/2B	15	48	52.5	33.5	106

Balancing the System

The hydronic circuits serving air conditioning systems must be balanced, meaning that they must be constructed in such a way as to guarantee the design flow rates of the thermal medium. Depending on the type of system and the appliances installed, and also on the type of control to be implemented, specific balancing devices are required.

Static balancing

Static-type devices are conventional devices suitable for use in constant flow rate circuits or circuits subject to limited load variations.

With static-type devices, the circuits are difficult to balance perfectly and have operating limitations in the case of partial closure by means of the regulating valves.

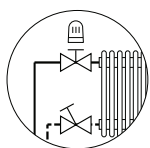

The flow rate in the open circuit does not remain constant at the nominal values

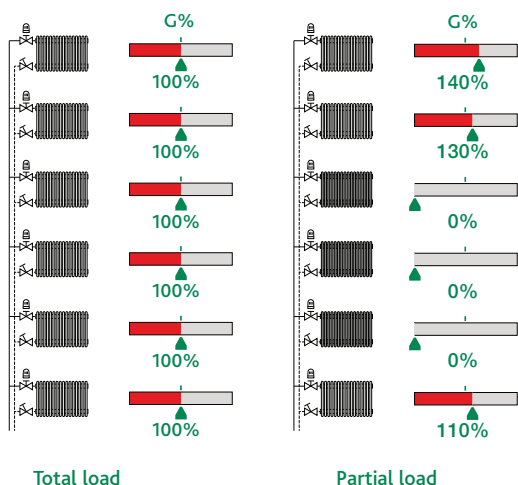

Operating principles

The dynamic thermostatic valve has been designed with the purpose of controlling a flow rate of thermal medium in the radiators of two-pipe heating systems that is:

- adjustable in accordance with the requirements of the part of the circuit controlled by the valve.
- constant despite any variation in differential pressure conditions in the circuit.

The valve in conjunction with a thermostatic control head, combines different functions in a single component:

- A **Differential pressure regulator**, which automatically cancels the effect of the pressure fluctuations typical of variable flow rate systems and prevents noisy operation.
- B **Device for pre-setting the flow rate**, which allows direct setting of the maximum flow rate value, in combination with the differential pressure regulator.
- C **Flow rate control depending upon the ambient temperature**, in combination with the thermostatic control head, the flow rate control is optimised because it is pressure-independent.

Dynamic balancing

Dynamic devices are modern automatic devices, mainly suitable for variable flow rate systems with thermal loads that change frequently.

They can balance the hydraulic system automatically, ensuring each terminal receives the design flow rate. Even in the case of partial circuit closure by means of the regulating valves, **the flow rates in the open circuits remain constant at the nominal value.**

This behaviour is maintained even if there is modulation of the loads, the flow rates remains constant at the specified value.

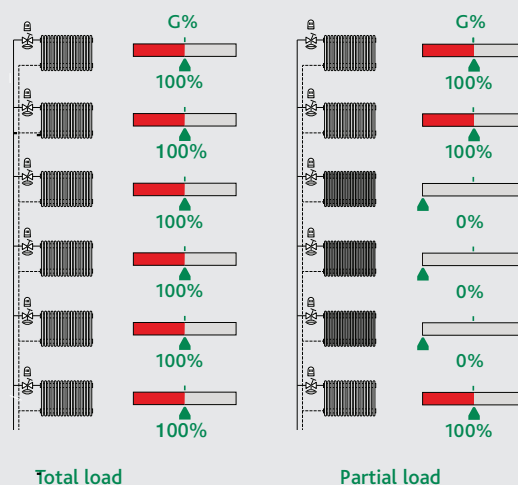
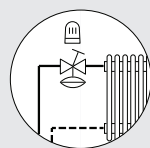

Operating principles continued

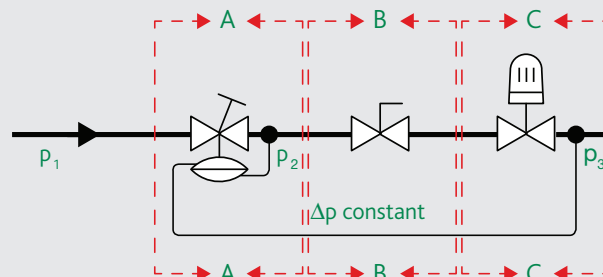

Where:

- p_1 = upstream pressure
- p_2 = intermediate pressure
- p_3 = downstream pressure
- $p_1 - p_3$ = total pressure
- $p_2 - p_3$ = constant Δp

Operating principles continued

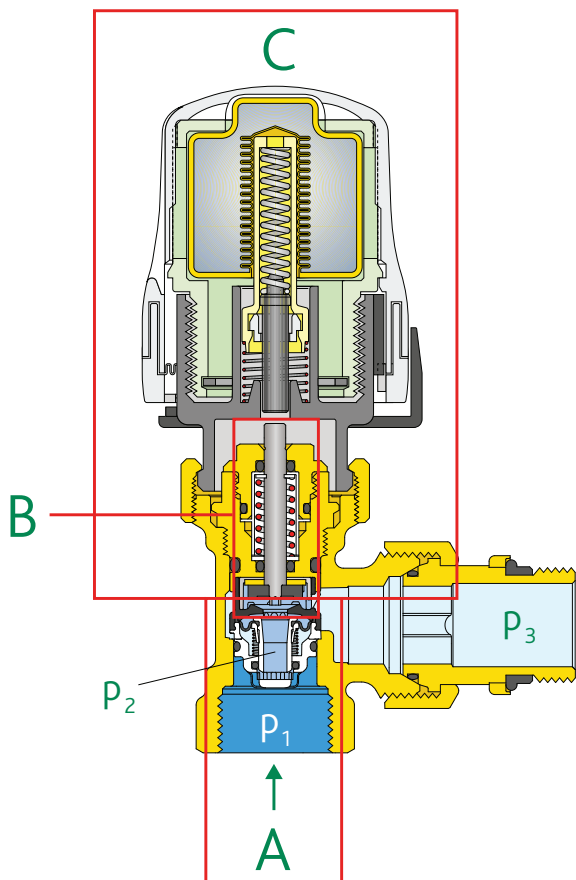

Device (A) regulates the Δp and keeps it constant across the device (B+C), by means of an automatic action (balancing between the force generated by the differential pressure and the internal opposing spring).

If (p_1-p_3) increases, the internal Δp regulator reacts to close the bore and maintains Δp constant; in these conditions the flow rate will remain constant.

Device (B) regulates flow rate G by changing its bore cross section. The change in bore cross section determines the hydraulic co-efficient value (K_v) of the regulator valve (B), which remains constantly at:

- a manually pre-set value
- a value determined by the actuator's regulating action.

Working range

For the valve to keep the flow rate constant independently from the circuit's differential pressure conditions, the total valve Δp (p_1-p_3) must be in the range between the minimum Δp value (10 kPa for adjustments from 1 to 4 and 15 kPa for adjustments 5 and 6) and the maximum value of 150 kPa.

Working range continued

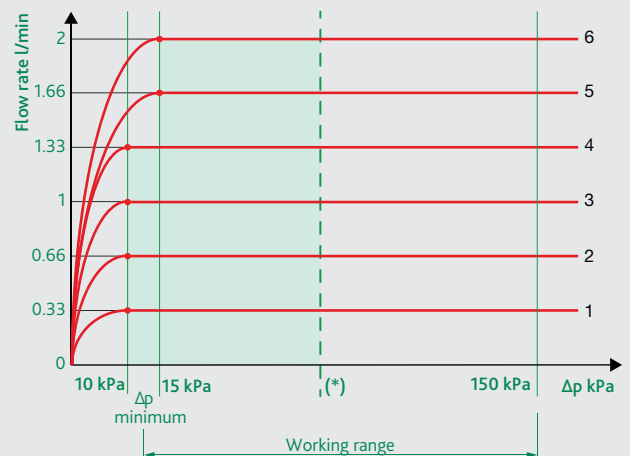

(*) Recommended working range: for the best dynamic behaviour without problems linked to the passage of the water flow through the valve it is recommended to work with $\Delta p < 70$ kPa.

Δp min (0.33 to 1.33 l/m): 10 kPa

Δp min (1.66 to 2.0 l/m): 15 kPa

Flow rate accuracy

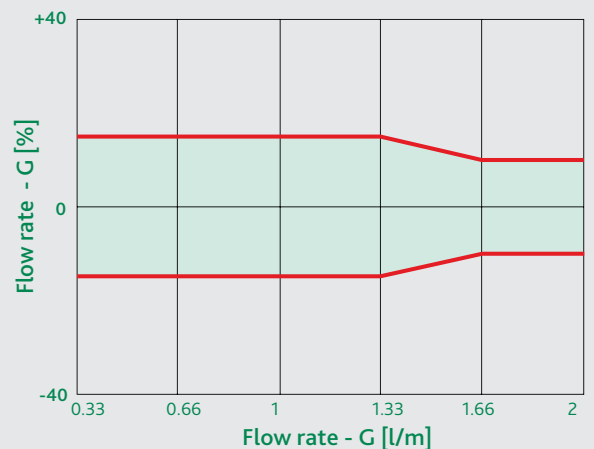

Δp min - 0.33 to 1.33 l/m: 10 kPa

Δp min - 1.66 to 2.0 l/m: 15 kPa

230 & 231 DYMANICAL® thermostatic radiator valves

Construction

Compact device

This dynamic valve has been designed with dimensions compatible with those of traditional valves, therefore in case of replacement no special adaptations are required.

IMPORTANT! The dynamic valve headwork cannot be installed in a traditional valve.

Headwork replacement

The headwork is pre-assembled in a single body containing all the regulating components.

It can be inspected for cleaning or replacement if necessary using the special headwork replacement kit (code 387201), without any need to remove the radiator valve from the pipe.

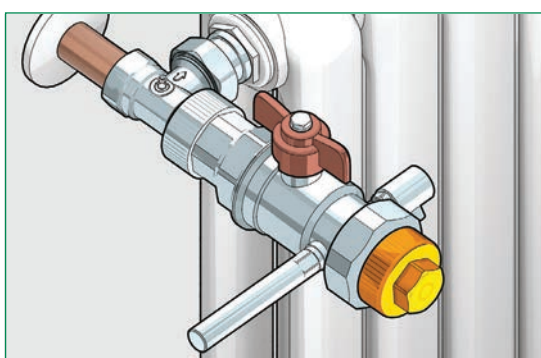

Valve Construction

The stainless steel control stem (1) has a double EPDM O-ring seal.

The EPDM obturator (2) is made so as to optimise the hydraulic characteristics of the valve during the progressive action of opening or closing in thermostatic operation.

The internal pre-setting device (3) is made of anti-seizing polymer.

The balancing membrane (4) is made of EPDM with high mechanical sensitivity combined with the spring and with the control device allows adjustment of the differential pressure.

There is a protective casing (5) to minimise the risk of dirt getting into the dynamic component.

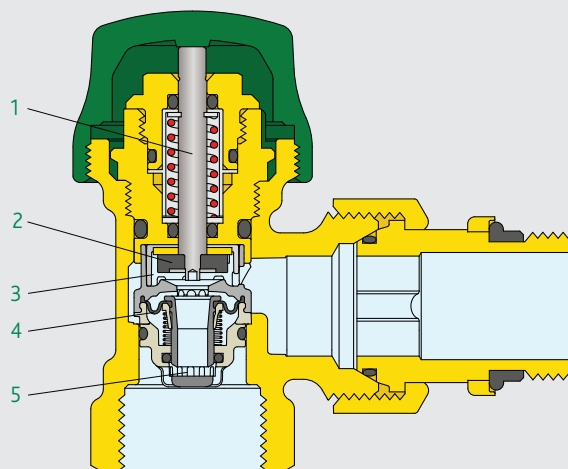

Ease of design

The presence of the internal device which is able to regulate the flow rate and stabilise the working Δp allows faster design and balancing operations: no support components are required for calculations and pre-setting is very simple.

Low flow valve hydraulic characteristics

Low flow valve without thermostatic control head

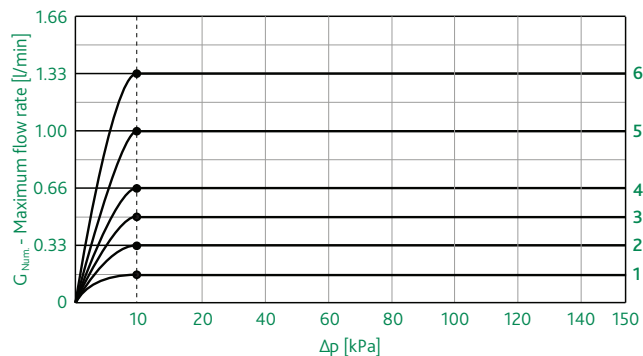

Low flow valve with thermostatic control head and 2K proportional band

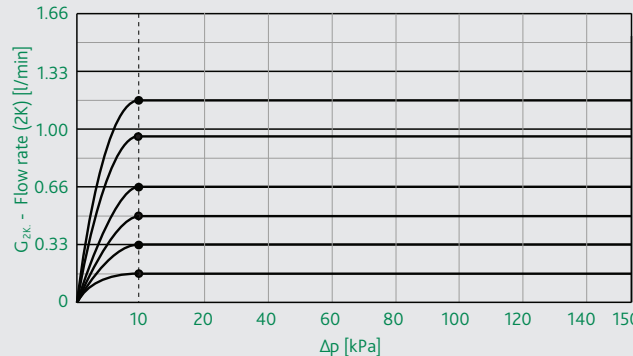

	Low flow pre-setting position					
	1	2	3	4	5	6
$G_{Num.}$ (l/m)	0.16	0.33	0.50	0.66	1.00	1.33
G_{2K} (l/m)	0.16	0.33	0.50	0.66	0.92	1.16

230 & 231 DYMANICAL® thermostatic radiator valves

Hydraulic characteristics

Without thermostatic control head

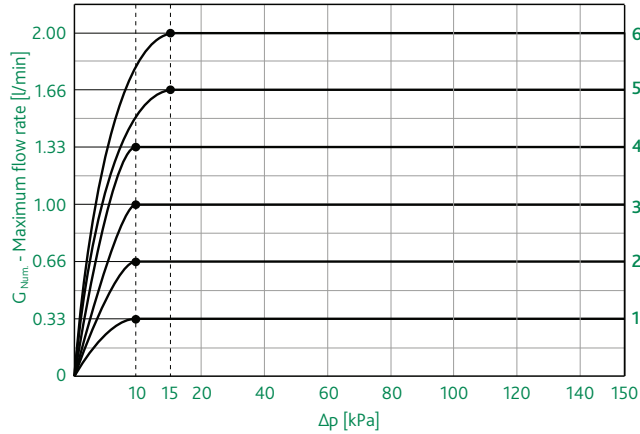

	Pre-setting position					
	1	2	3	4	5	6
$G_{Num.}$ (l/m)	0.33	0.66	1.00	1.33	1.66	2.00
G_{2K} (l/m)	0.33	0.66	0.92	1.17	1.33	1.50

System sizing

For correct system sizing, the valves are normally selected by determining the pre-setting value based on the design flow rate on the diagram with thermostatic control head and 2K proportional band.

Stepped adjustment, not continuous.

With thermostatic control head and 2K proportional band

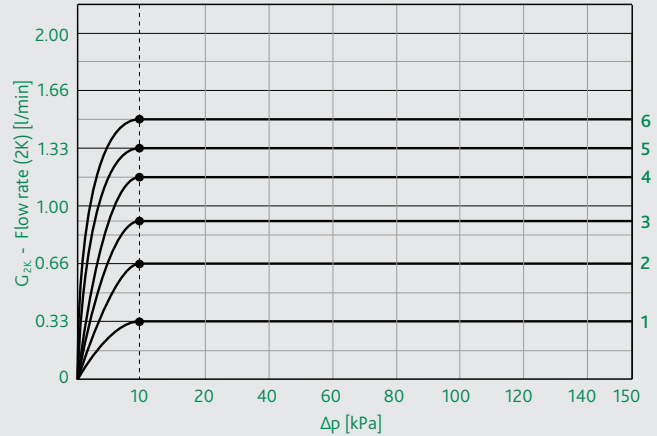

Example of pre-setting using standard 1/2" dymanic thermostatic valve

Let us suppose we have to balance three circuits having the following characteristics:

Design power	Circuit 1	$Q_1 = 30$ kcal/min
	Circuit 2	$Q_2 = 12.5$ kcal/min
	Circuit 3	$Q_3 = 26.6$ kcal/min
Design temperature difference		$\Delta T = 20$

Design flow rate

The design flow rate for each radiator is calculated with the equation:

	$G = Q/\Delta T$
Circuit 1	$G_1 = 1.50$ l/m
Circuit 2	$G_2 = 0.625$ l/m
Circuit 3	$G_2 = 1.33$ l/m

Pre-setting and effective flow rate

The setting positions can be easily determined based on the design flow rates from the graph or from the table shown in the paragraph "Hydraulic characteristics" (considering 2K adjustment for sizing).

Circuit 1	pos 6	$G_1 = 1.50$ l/m
Circuit 2	pos 5	$G_2 = 0.667$ l/m
Circuit 3	pos 2	$G_2 = 1.33$ l/m

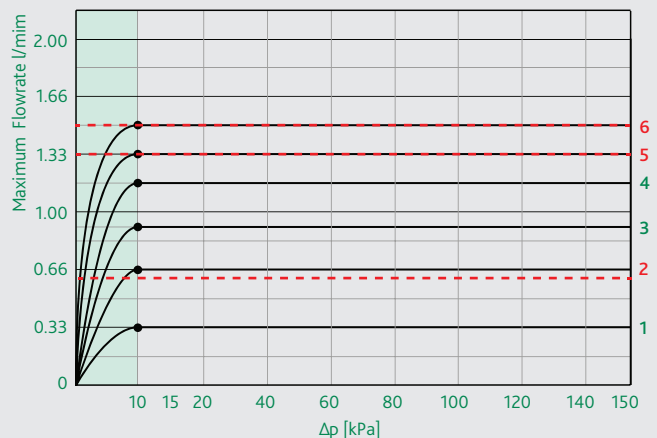

Minimum operating Δp: on site check of the least favoured circuit

The dynamic thermostatic valve, with 2K adjustment, works between 10 kPa and 150 kPa. For this reason it is necessary to identify the most least favoured circuit and determine the available Δp using the Δp measuring kit code 230100 and ensure the minimum operating Δp to this circuit, adjusting the circulation pump head.

The most least favoured circuit, to ensure the minimum operating Δp can be identified through the rigorous calculation of the head losses.

- 1 Cal. of the head loss of every single radiator circuit (ΔpC)

$$\Delta p_C = \Delta p_{min} + \Delta p_{T/R}$$

where:

Δp_{min} minimum working Δp of the DYNAMICAL® valve

Δp_{T/R} head losses in the pipes / radiator. (*)

Consequently:

	Circuit 1	Circuit 2	Circuit 3
Δp _{min}	10 kPa	10 kPa	10 kPa
Δp _{T/R}	2.5 kPa	3 kPa	2 kPa
Δp _C	12.5 kPa	13 kPa	12 kPa

- 2 Cal. of the head loss of the connecting section (Δp_{TC}). (*)

	Section 0-1	Section 1-2	Section 2-3
Δp _{TC}	4 kPa	2 kPa	1.5 kPa

(*) In the example, for the sake of simplicity the values are assumed to be known without giving the whole calculation.

- 3 Calculation of the total head losses of each circuit with respect to the circulator. (Δp_{TOT}).

$$\begin{aligned} \text{Circuit 1} \quad \Delta p_{TOT1} &= \Delta p_{TC\ 0-1} + \Delta p_{C1} \\ &= 4 + 12.5 = 16.5 \text{ kPa} \end{aligned}$$

$$\begin{aligned} \text{Circuit 2} \quad \Delta p_{TOT2} &= \Delta p_{TC\ 0-1} + \Delta p_{TC\ 1-2} + \Delta p_{C2} \\ &= 4 + 2 + 13 = 19 \text{ kPa} \end{aligned}$$

$$\begin{aligned} \text{Circuit 3} \quad \Delta p_{TOT3} &= \Delta p_{TC\ 0-1} + \Delta p_{TC\ 1-2} + \Delta p_{TC\ 2-3} + \Delta p_{C3} \\ &= 4 + 2 + 1.5 + 12 = 19.5 \text{ kPa} \end{aligned}$$

In the example, the most least favoured circuit is number 3, which corresponds to the maximum total head loss.

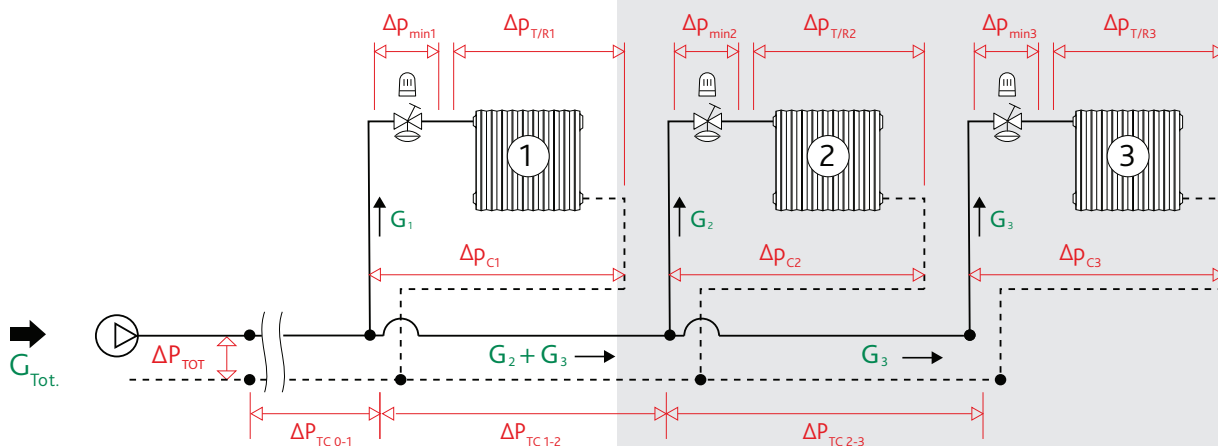

Minimum operating Δp: on site check of the disadvantaged circuit

The dynamic thermostatic valve, with 2K adjustment, works between 10 kPa and 150 kPa. For this reason it is necessary to identify the most least favoured circuit and determine the available Δp using the Δp measuring kit code 230100 and ensure the minimum operating Δp to this circuit, adjusting the circulation pump head.

Determining the circulation pump flow rate

The flow rate of the circulation pump is calculated, with sufficient accuracy, as the sum of the G_{max} flow rates of the radiators (a). Therefore:

$$G_{pump} = \sum G_{max}$$

In a theoretically more accurate way, the flow rate can also be calculated as the sum of the flow rates at which the DYNAMICAL® valves are set (b).

In the previous example:

$$(a) \quad \sum G_{max} = 3.46 \text{ l/min}$$

$$(b) \quad pos. 6 + pos. 2 + pos. 5 = 1.5 + 0.66 + 1.33 = 3.5 \text{ l/min}$$

the differences involved between the two methods are not very high.

Determining the circulation pump head

The head of the circulation pump is calculated as the sum of the head losses of the most disadvantaged circuit.

Δp_{Disadvantaged C} (including the working Δp_{min} of the DYNAMICAL® valve and the pipe/radiator losses Δp_{T/R}) and the Δp of the pipework connecting that circuit to the circulation pump.

Therefore:

$$\Delta p_{pump} = \Delta p_{min} + \Delta p_{T/R\ disadvantaged} + \sum \Delta p_{connecting\ sections}$$

In the case in the example:

$$\Delta p_{pump} = \Delta p_{TOT3}$$

230 & 231 DYMANICAL® thermostatic radiator valves

Pre-setting and installation of the thermostatic heads, electronic or thermo-electric actuators.

Remove the knob from the valve.

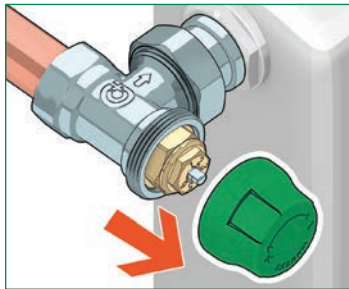

To pre-set the flow rate, position the setting tool on the control stem.

The setting position is defined by the orientation of the flat side surface (1) of the control stem.

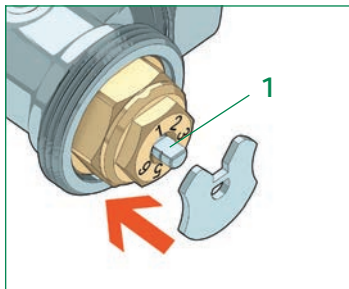

Rotate the control stem to select the desired position.

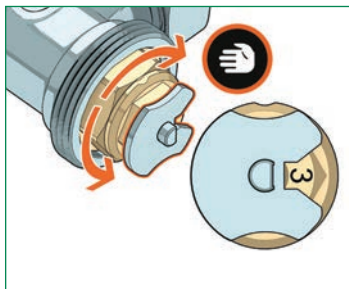

Remove the setting tool

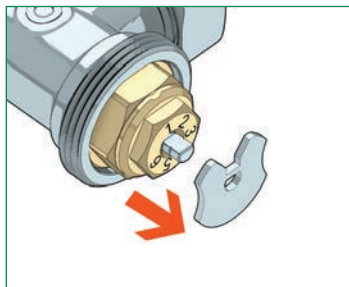

Pre-setting and installation of the thermostatic heads, electronic or thermo-electric actuators

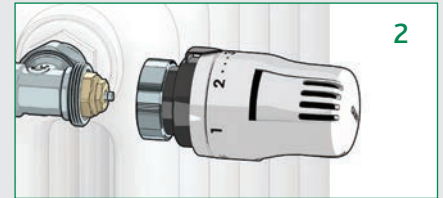

Install the thermostatic (2), electronic (3) or thermo-electric (4) actuator onto the valve.



230 & 231 DYMANICAL® thermostatic radiator valves

Installation of the valve with thermostatic head

The thermostatic control heads must be installed horizontally.

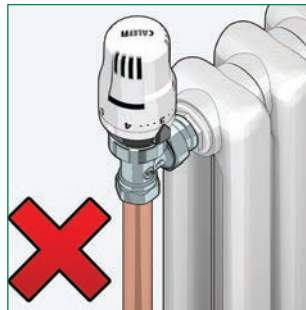
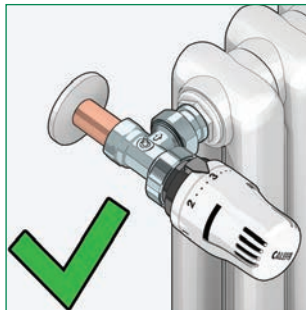

The sensitive element of the thermostatic control heads must never be installed in niches, radiator cabinets, behind curtains or exposed to direct sunlight, otherwise it may produce false readings.

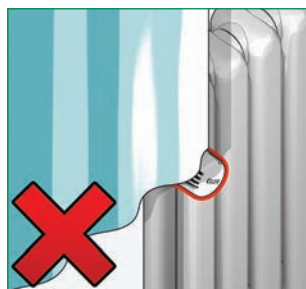
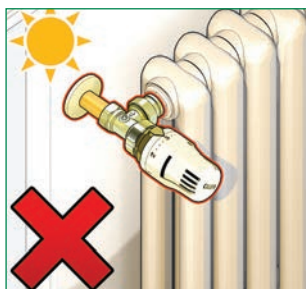
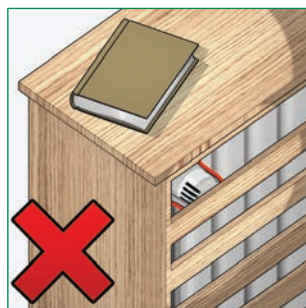

Operating principles of the thermostatic control head

The control device of the thermostatic valve is a proportional temperature regulator, composed of a bellows containing a specific thermostatic liquid.

As the temperature increases, the liquid increases in volume and causes the bellows to expand.

As the temperature decreases, the inverse process occurs; the bellows contracts due to the thrust of the counter-spring.

The axial movements of the sensor element are transmitted to the valve actuator by means of the connecting stem, thereby adjusting the flow of medium in the heat emitter.

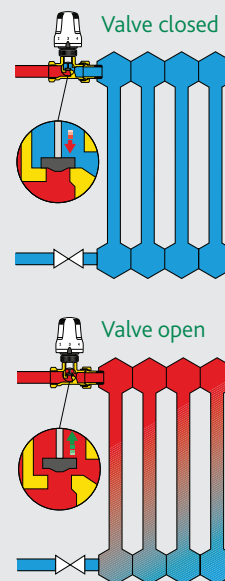

Combination with heat metering systems

The thermostatic valves can be used in combination with metering systems.

In this way, the actual consumption of each radiator can be monitored in order to contain system running costs which, in centralised systems, can be shared in such a way to be advantageous to the end users.

Technical Specification 200-201-202 & 204 thermostatic controllers

Adjustment scale:	✱ to 5
Adjustment temperature range:	7 to 28°C
Frost protection cut-in:	7°C
Max. ambient temperature:	50°C
Length of capillary for 201 controller and code 199100:	2 m
Room temperature indicator 202 series:	16 to 26°C

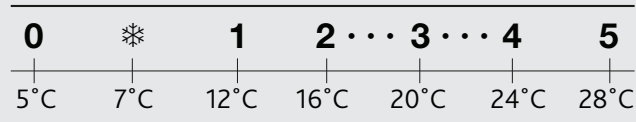

Technical Specification for 656 thermo-electric actuator

Normally closed	
Electricity supply:	230 V (ac) or 24 V (ac/(dc))
Power consumption:	3W
Protection class:	IP 44 (in vertical position)
Electricity supply cable:	80 cm

230 & 231 DYMANICAL® thermostatic radiator valves

Typical applications

System with risers with dynamic thermostatic valves and thermostatic control heads.

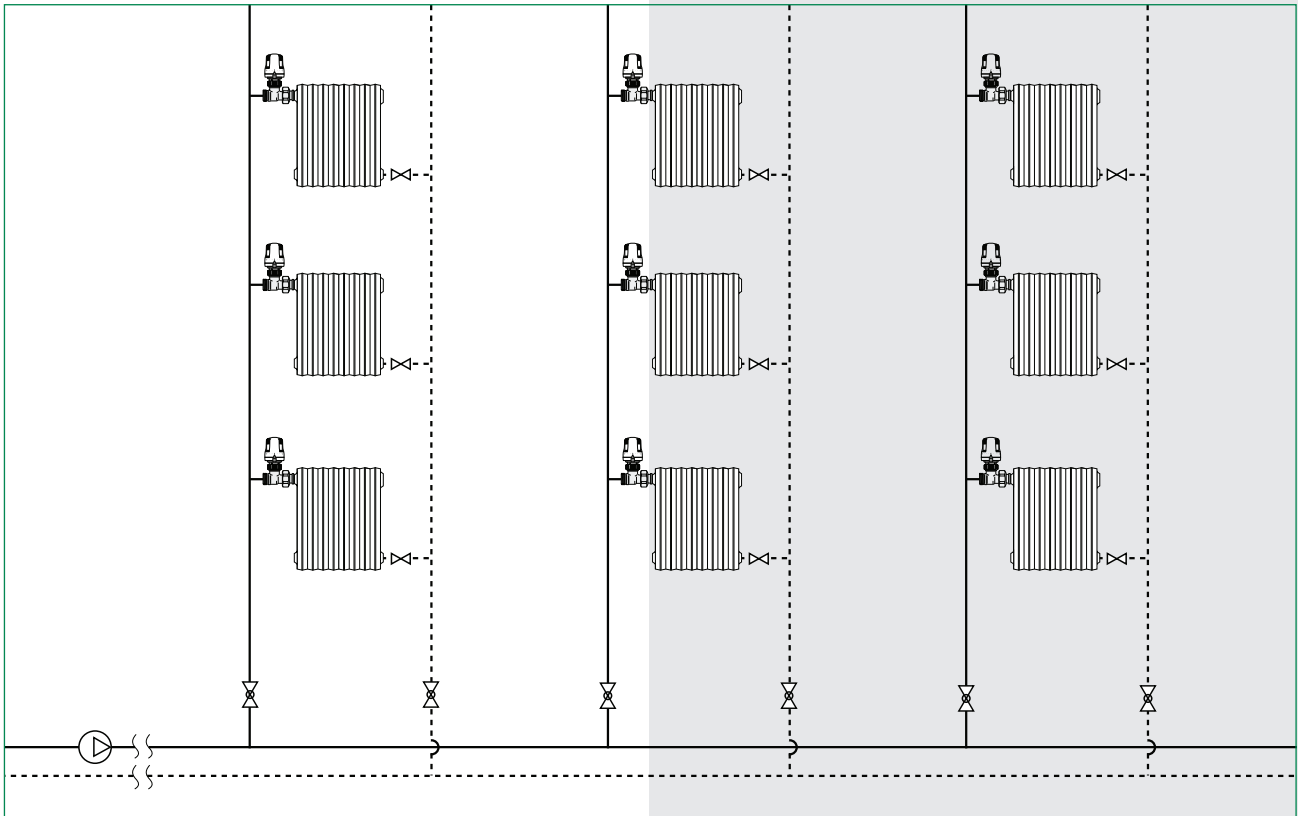

Independent zone system with dynamic thermostatic valves with thermostatic control heads and variable speed circulator

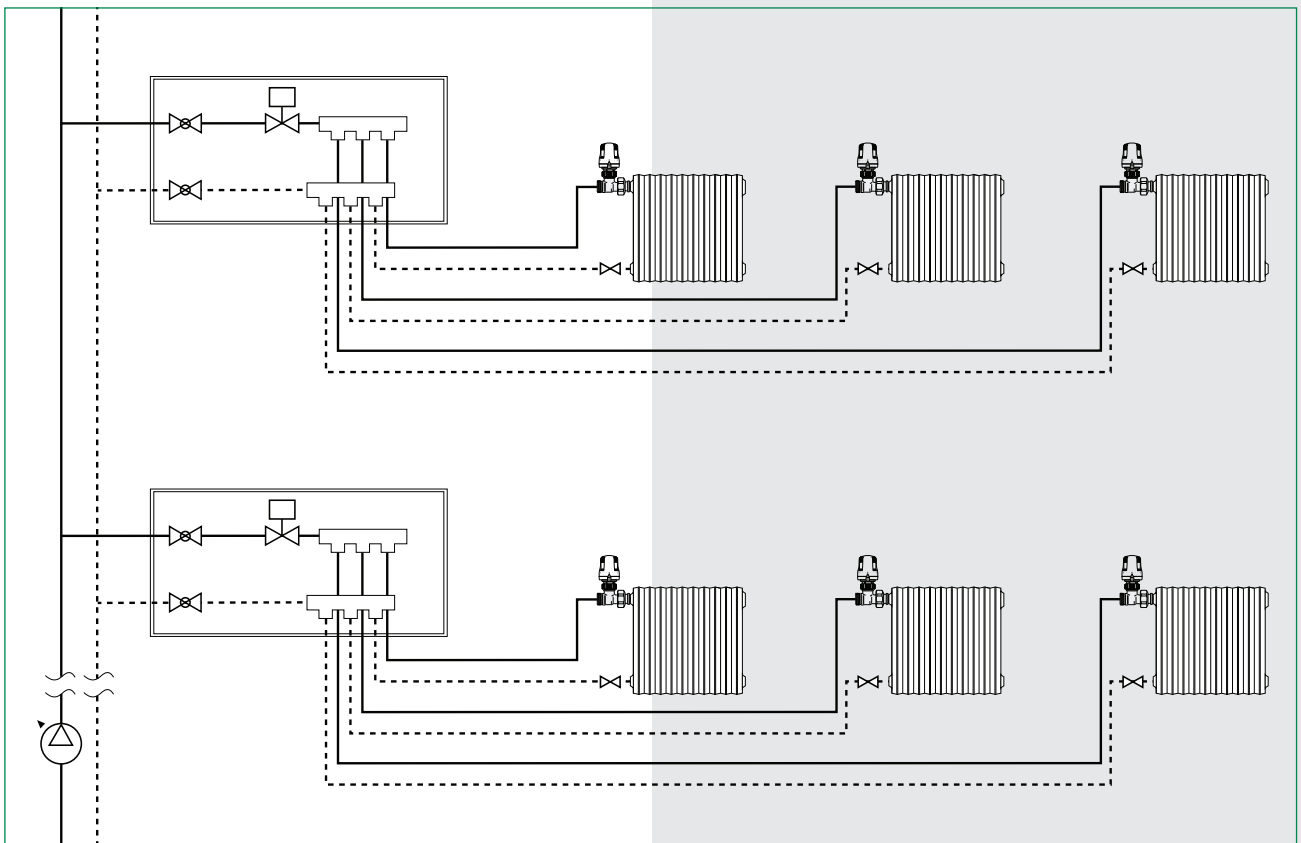

230 & 230 DYMANICAL® thermostatic radiator valves

Control heads



Thermostatic control heads and thermostatic actuators

- Code 204000 Thermostatic control head with built-in sensor with liquid-filled element
- Code 204100 Thermostatic control head with remote sensor liquid-filled element
- 200 series Thermostatic control head with built-in sensor with liquid-filled element
- 201 series Thermostatic control head with remote sensor liquid-filled element
- 202 series Thermostatic control head with built-in sensor with temperature indicator
- 656 series Thermo-electric actuator

© Patents & Design Altecnic 2020

Altecnic Ltd retains all rights (including patents, designs and copyrights, trademarks and any other intellectual property rights) in relation to all information provided on or via the website, brochures or any other documents, including all texts, graphics and logos, contained on the website, in brochures or in any other documents published in the name of or on behalf of Altecnic Ltd in any form, without prior written consent of Altecnic Ltd.

Altecnic Ltd Mustang Drive, Stafford, Staffordshire ST16 1GW

T: +44 (0)1785 218200 E: sales@altecnic.co.uk

Registered in England No: 2095101

altecnic.co.uk

AL 298 12-10-20

E & O.E

© Altecnic Limited. 2020

ALTECNIC™

altecnic
CALEFFI group